

SELECT MOUNTING OPTION

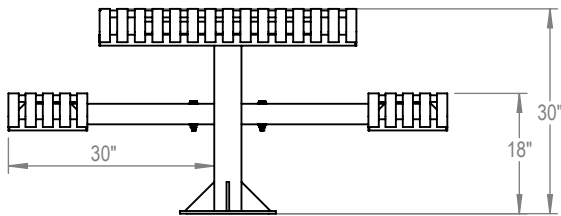

SURFACE MOUNT

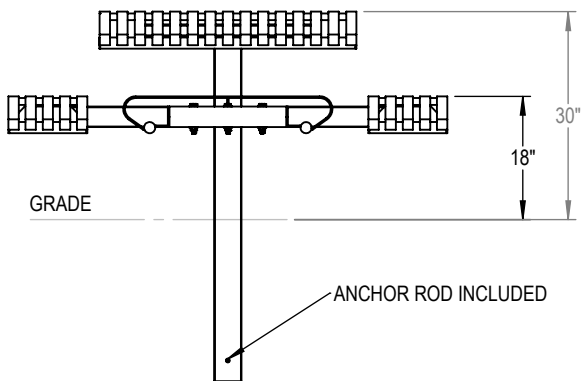

IN GROUND MOUNT

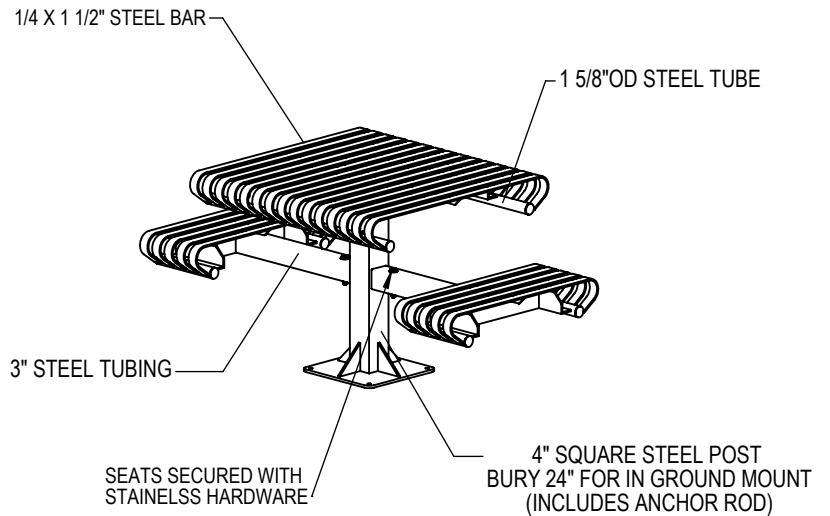

PRODUCT: CRT3-2
 DESCRIPTION: CARNIVAL TABLE, 3 FT. SQUARE, 2 SEATS,
 PEDESTAL MOUNT

DATE: 7-9-14
 ENG: SMC

CONFIDENTIAL DRAWING AND INFORMATION IS NOT TO BE COPIED OR DISCLOSED TO OTHERS WITHOUT THE CONSENT OF GRABER MANUFACTURING, INC. SPECIFICATIONS ARE SUBJECT TO CHANGE WITHOUT NOTICE.

©2014 GRABER MANUFACTURING, INC. ALL PROPRIETARY RIGHTS RESERVED.

ALL FASTENERS ARE STAINLESS STEEL
 SOME ASSEMBLY REQUIRED

SITE FURNISHING IS POWDER COATED WITH TGIC POLYESTER. STEEL SURFACE PREP INCLUDES MECHANICAL AND CHEMICAL ETCHING FOLLOWED WITH A COATING TO IMPROVE ADHESION AND CORROSION RESISTANCE.