

ALL FASTENERS ARE STAINLESS STEEL
 36 GALLON PLASTIC LINER INCLUDED
 REMOVED FROM ILLUSTRATIONS FOR CLARITY

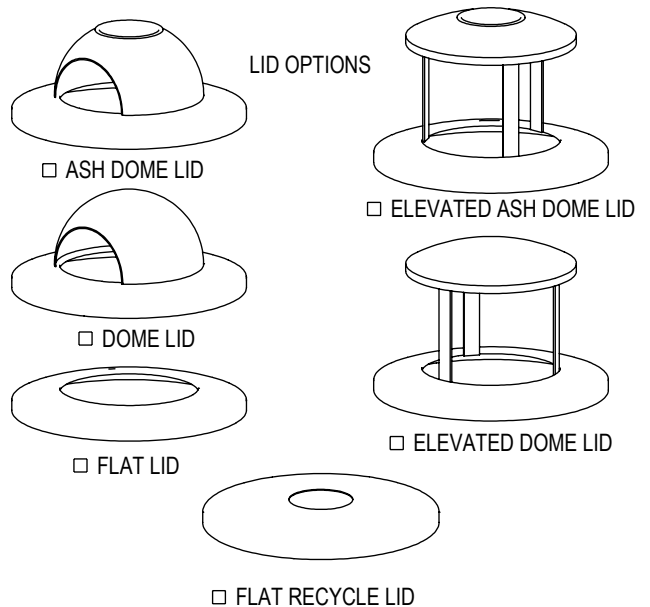

PRODUCT: CRTR-36-DOOR
 DESCRIPTION: CARNIVAL TRASH RECEPTACLE 36 GALLON, WITH DOOR

DATE: 1-21-15
 ENG: SMC

CONFIDENTIAL DRAWING AND INFORMATION IS NOT TO BE COPIED OR DISCLOSED TO OTHERS WITHOUT THE CONSENT OF GRABER MANUFACTURING, INC. SPECIFICATIONS ARE SUBJECT TO CHANGE WITHOUT NOTICE.

©2015 GRABER MANUFACTURING, INC. ALL PROPRIETARY RIGHTS RESERVED.

SITE FURNISHING IS POWDER COATED WITH TGIC POLYESTER. STEEL SURFACE PREP INCLUDES MECHANICAL AND CHEMICAL ETCHING FOLLOWED WITH A COATING TO IMPROVE ADHESION AND CORROSION RESISTANCE.