

LOCKING OPTION

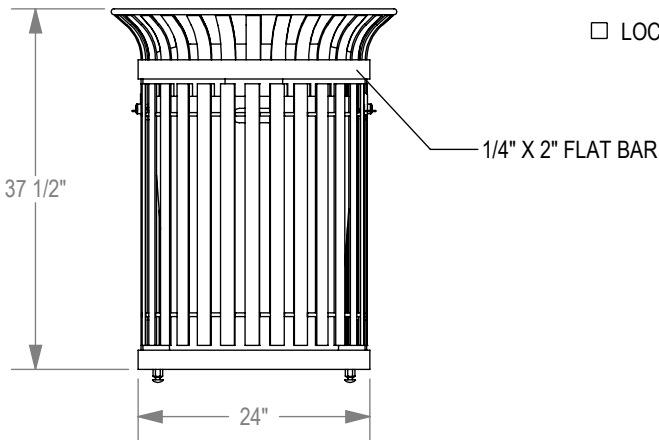

LID OPTIONS

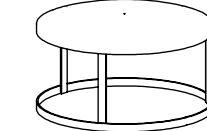
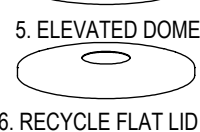
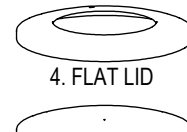
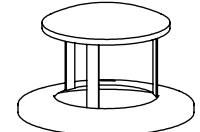
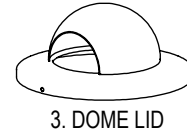
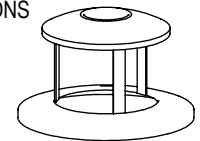

ALL FASTENERS ARE STAINLESS STEEL

PRODUCT: CRTR2-32-DOORS
DESCRIPTION: CARNIVAL DUAL TRASH RECEPTACLE, WITH DOORS

DATE: 1-22-15
ENG: SMC

CONFIDENTIAL DRAWING AND INFORMATION IS NOT TO BE COPIED OR DISCLOSED TO OTHERS WITHOUT THE CONSENT OF GRABER MANUFACTURING, INC. SPECIFICATIONS ARE SUBJECT TO CHANGE WITHOUT NOTICE.

©2015 GRABER MANUFACTURING, INC. ALL PROPRIETARY RIGHTS RESERVED.

SITE FURNISHING IS POWDER COATED WITH TGIC POLYESTER. STEEL SURFACE PREP INCLUDES MECHANICAL AND CHEMICAL ETCHING FOLLOWED WITH A COATING TO IMPROVE ADHESION AND CORROSION RESISTANCE.