

ARM OPTION - SPECIFY  
 NUMBER OF ARMS DESIRED \_\_\_\_\_

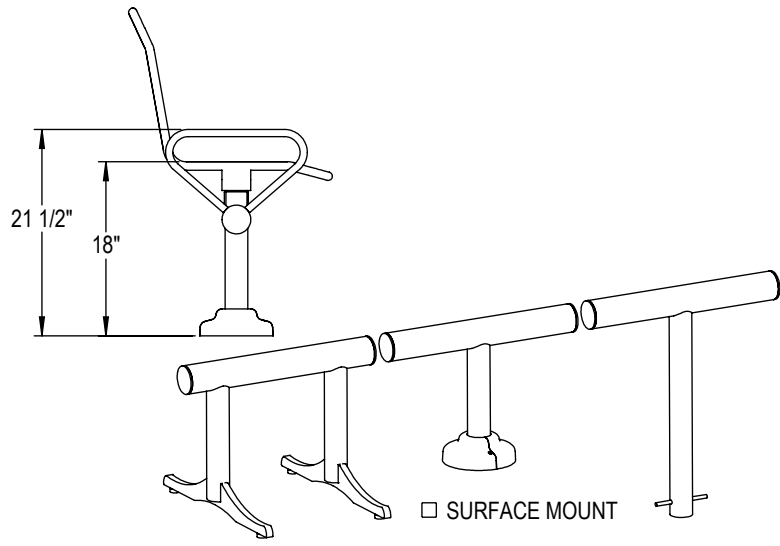
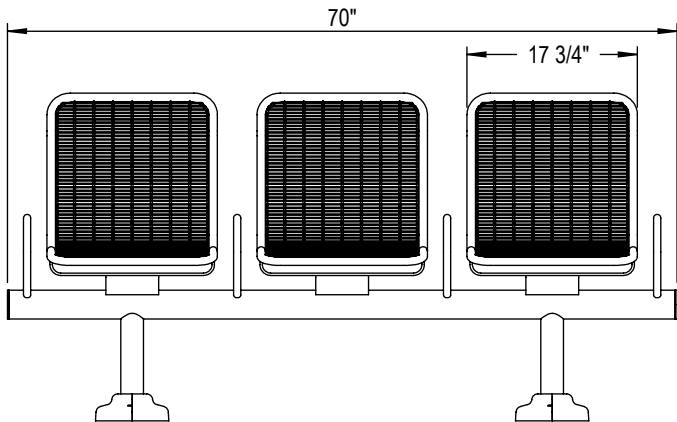
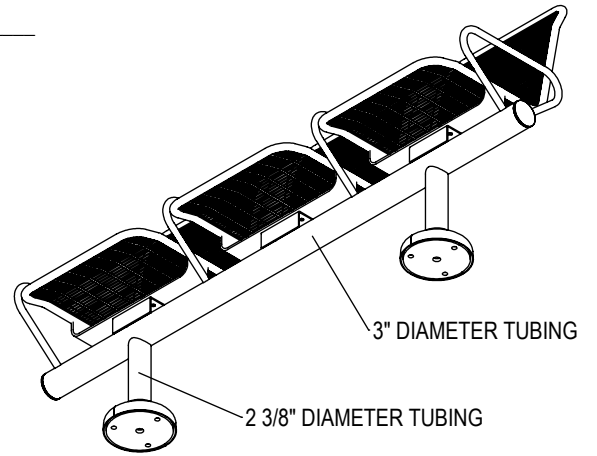
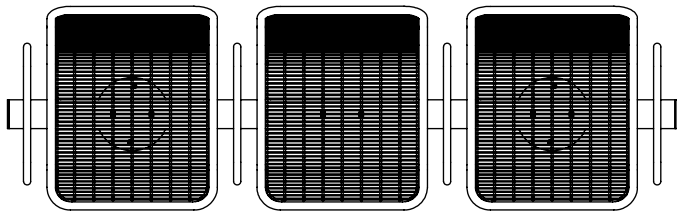

FREE STANDING  SURFACE MOUNT  IN GROUND

CHECK DESIRED MOUNT

PRODUCT: CNMB-3  
 DESCRIPTION: CUNNINGHAM BACKED MODULAR BENCH,  
 3 SEAT  
 DATE: 10-6-15  
 ENG: SMC

ALL FASTENERS ARE STAINLESS STEEL  
 SOME ASSEMBLY REQUIRED

SITE FURNISHING IS POWDER COATED WITH TGIC POLYESTER.  
 STEEL SURFACE PREP INCLUDES MECHANICAL AND CHEMICAL  
 ETCHING FOLLOWED WITH A COATING TO IMPROVE ADHESION  
 AND CORROSION RESISTANCE.

CONFIDENTIAL DRAWING AND INFORMATION IS NOT TO BE COPIED OR DISCLOSED  
 TO OTHERS WITHOUT THE CONSENT OF GRABER MANUFACTURING, INC.  
 SPECIFICATIONS ARE SUBJECT TO CHANGE WITHOUT NOTICE.

©2015 GRABER MANUFACTURING, INC. ALL PROPRIETARY RIGHTS RESERVED.